

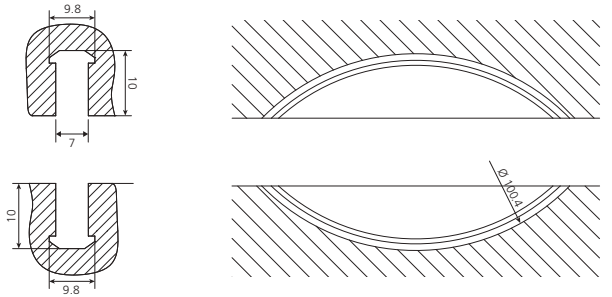

Tenso P-10

Pat. pend.

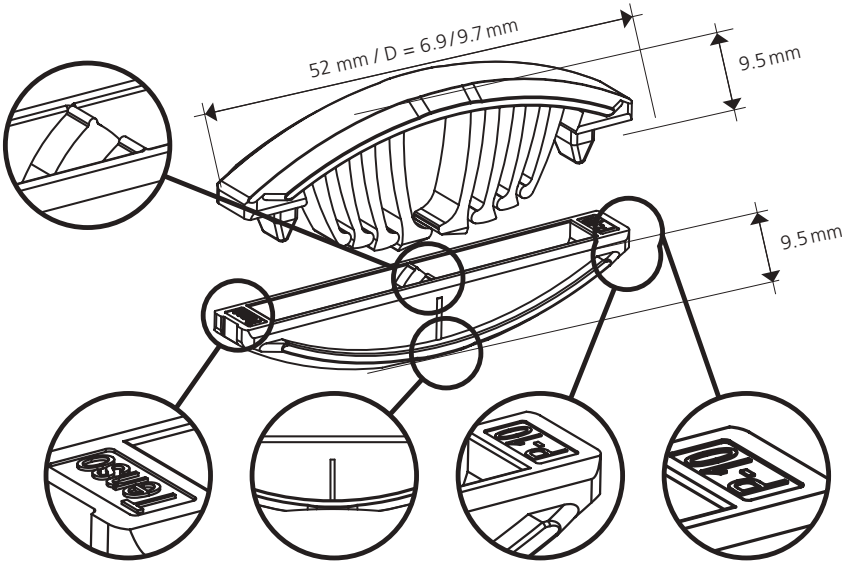

Anzugskraft / Tensile Force: 100 N

Haltekraft / Retention Force: 180 N

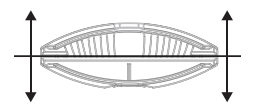
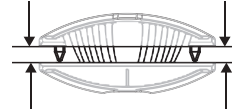

Hinweis: Die Zug- bzw. Scherfestigkeit ist abhängig vom Klebstoff / Tip: The tensile or shear strength depends on the used adhesiv

Immer in Verbindung mit Klebstoff verwenden

Hinweis:

- Trockener Zusammenbau mit **Bisco P-10** möglich
- Bei Arbeiten mit 12 mm bzw. 13 mm dicken Materialien muss mindestens eine 1 mm Kante verwendet werden

Always use in combination with glue

Tip:

- Test assembly with **Bisco P-10** possible
- When working with 12 mm or 13 mm thick materials at least one 1mm edge must be used

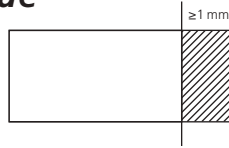

Wichtig: Für eine maximale Spannkraft!
Important: For maximum clamping force!

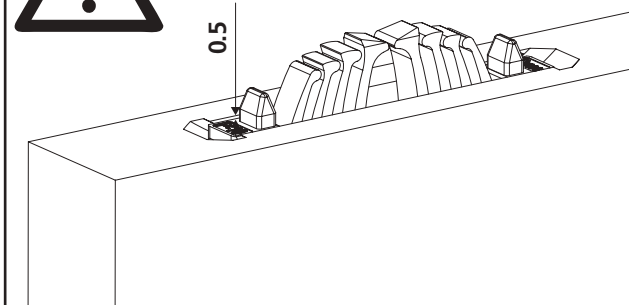

Zeta P2

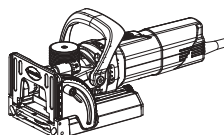

Art.Nr. 101402



Art.Nr. 132140 (Diamant)
DP, Ø 100.4 x 7 x 22 mm



Art.Nr. 132141
HW, Ø 100.9 x 7 x 22 mm

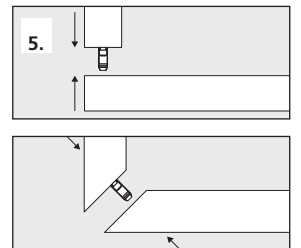
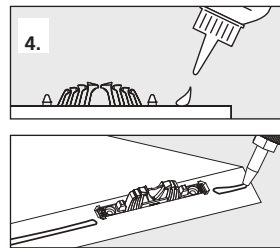
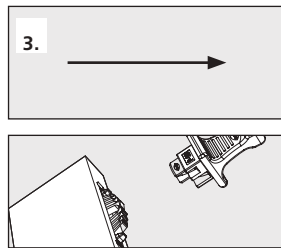
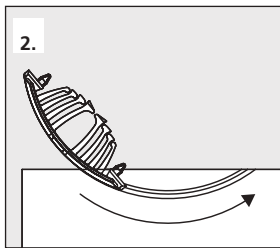
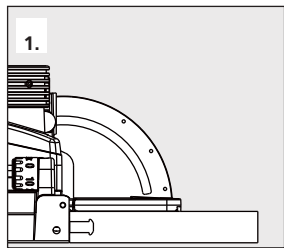
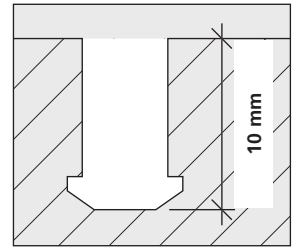
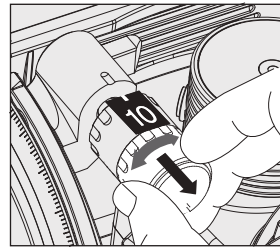

Scharfe Fräser verwenden
Use sharp cutters



max. 30 min



Anwendungen / Applications

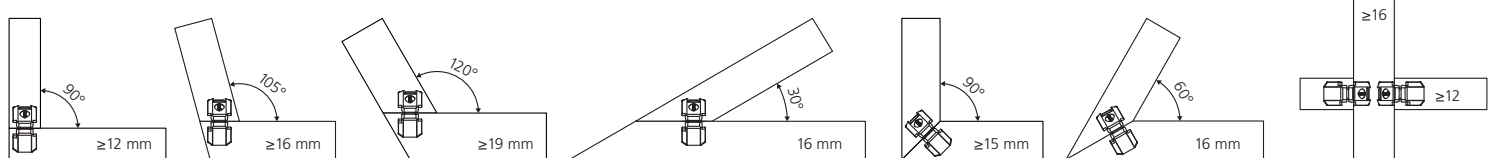

Versetzter Einbau / Offset installation

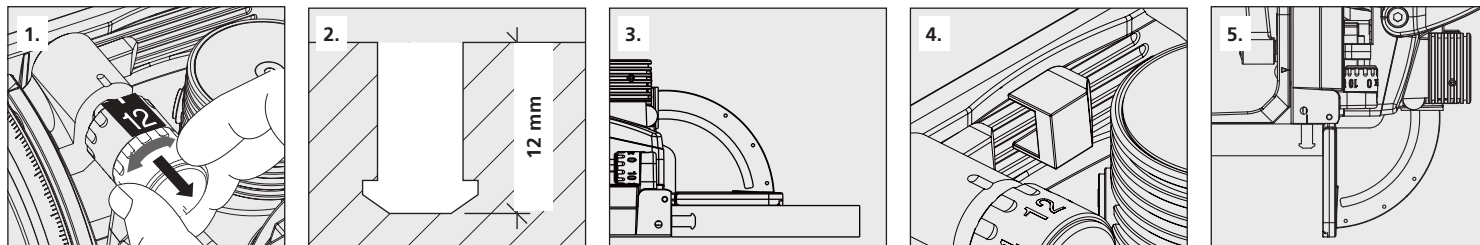

P-12 P-8 P-12

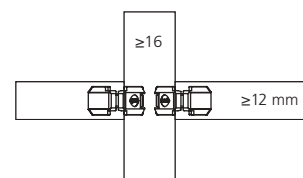
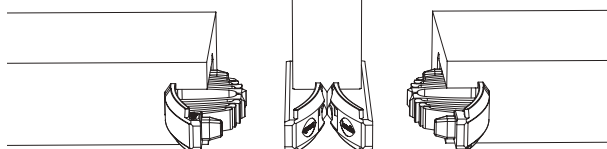
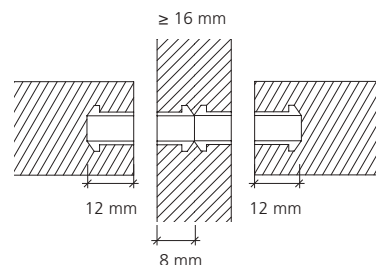

CNC | Partner network: www.lamello.ch

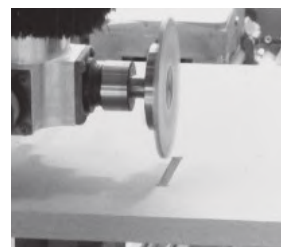
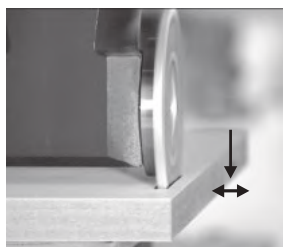
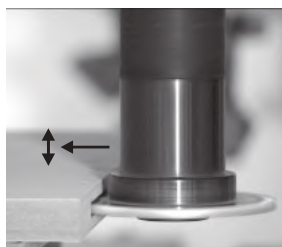
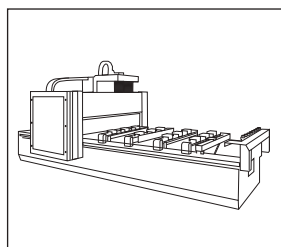

Art.Nr. 132142

DP, 100.4 × 7 × 30 mm
4 / 6.6 / DTK 48 mm

* Passend zu allen aufgeführten Fräsdornen /
Suitable for all cutter arbors listed

Art.Nr. 132143

DP, 100.4 × 7 × 40 mm
4 / 5.5 / DTK 52 mm

Art.Nr. 132144

DP, 100.4 × 7 × 16 mm
4 / 5.5 / DTK 28 mm



*** Art.Nr. 132150**

20 × 50, L = 102 mm

*** Art.Nr. 132151**

25 × 60, L = 102 mm

*** Art.Nr. 132152**

16 × 50, L = 85 mm

*** Art.Nr. 132153**

16 × 55, L = 68 mm

*** Art.Nr. 132154**

16 × 50, L = 85 mm, mit Spannfläche (2°-schräg) / with clamping surface (2°-angle)

*** Art.Nr. 132155**

20 × 50, L = 85 mm, mit Spannfläche (2°-schräg) / with clamping surface (2°-angle)



Art.Nr. 145439

Tiefenstelleraufsatz /
Depth adjuster cap

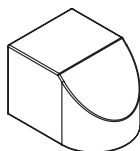

Stück/Piece/ Pièce/Pezzi	Art.Nr.
1	145439

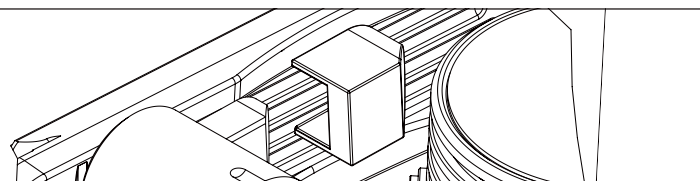

Divario P-18

Tenso P-14

Tenso P-10

**Clamex P Medius
14/10**

Clamex P-14

Clamex P-10

**Bisco P-14
Bisco P-10**



Paar/Pair/ Paire/Paio	Art.Nr.	Paar/Pair/ Paire/Paio	Art.Nr.
80	145550	80	145415
300	145560	300	145425
1000	145570	1000	145435

Paar/Pair/ Paire/Paio	Art.Nr.
80	145418
300	145428
1000	145438

Paar/Pair/ Paire/Paio	Art.Nr.
80	145370
300	145371
1000	145357

Paar/Pair/ Paire/Paio	Art.Nr.
80	145334
300	145346
1000	145356

Paar/Pair/ Paire/Paio	Art.Nr.
80	145372
300	145373
1000	145374

Stück/Piece/ Pièce/Pezzi	Art.Nr.
P-10 80	145304
300	145305
P-14 80	145301
300	145302
1000	145303