

opk SPACESHIP 80 W/G

Pocket

GERINGE GRÖSSE. MAXIMALE ERGEBNISSE.
SMALL SIZE. MAXIMUM RESULTS.
UNE TAILLE COMPACTE. DES RÉSULTATS REMARQUABLES.

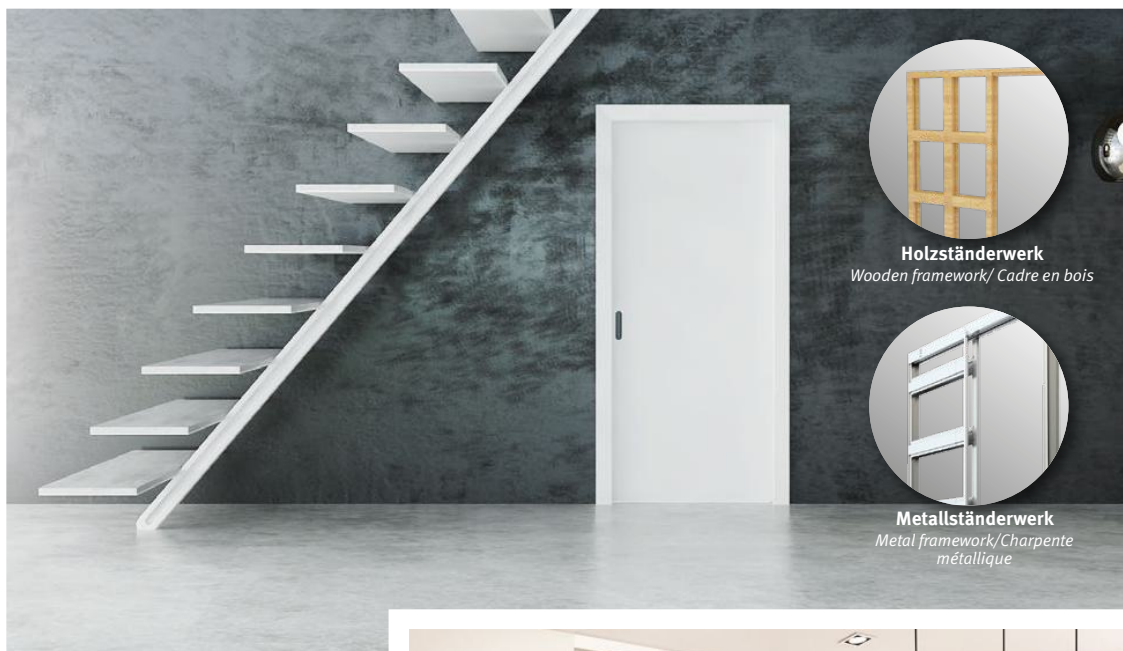

Holzständerwerk
Wooden framework/ Cadre en bois



Metallständerwerk
Metal framework/Charpente métallique

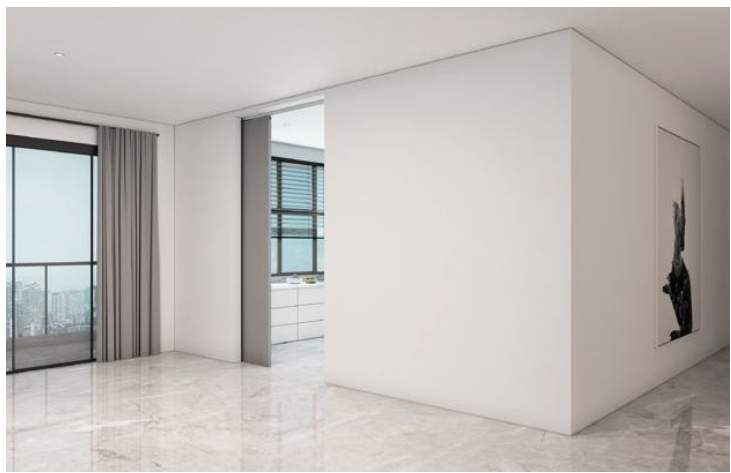
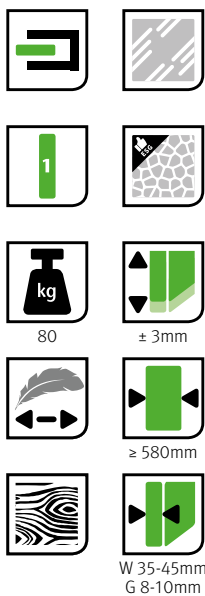

Bausysteme
Building systems /
Systèmes de construction

opk Spaceship 80 W

Standard Pocket



Art.-Nr. /
No. / N° d'art.

		≤80	≥580	03-011-803-200
--	--	-----	------	----------------

Konfiguration für 1 Tür

Configuration for 1 door / Configuration pour 1 porte



Laufwerk mit 2-Wege Dämpfer <i>Running part with two-way damper / Train de roulement avec amortisseur 2 voies</i>		1
Laufwerk <i>Running part (roller) / Train de roulement</i>		1
Aktivator lang <i>Activator long / Activateur long</i>		1
Aktivator <i>Activator / Activateur</i>		1
Aufhängung Holz <i>Suspension bracket wood / Suspension bois</i>		2
Bodenführung Pocket Holz <i>Floor guide pocket bracket wood / Guide Pocket bois</i>		1
Endstopper <i>End Stopper / Butée d'extrémité</i>		2
Endkappe Führungsschiene <i>Cover cap guiding track / Embout rails de guidage</i>		1
Führungsschwert unten <i>Guiding sword floor bottom / Guide épée en bas</i>		1
Zubehörset Pocket Holz <i>Accessories pocket wood / Set d'accessoires Pocket verre Pocket bois</i>		1

opk Spaceship 80 W Minimal Pocket



Technische Zeichnung Technical drawing / Plans et schémas

Profilgrößen Profile dimensions Tailles des profil

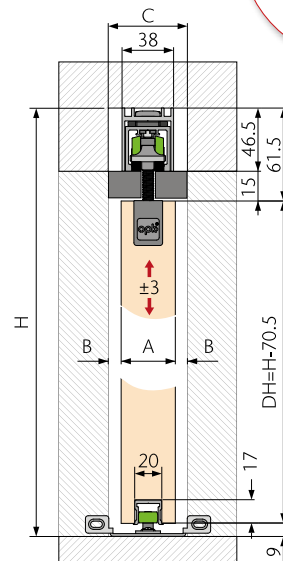
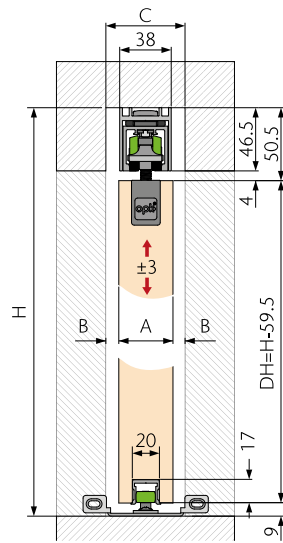
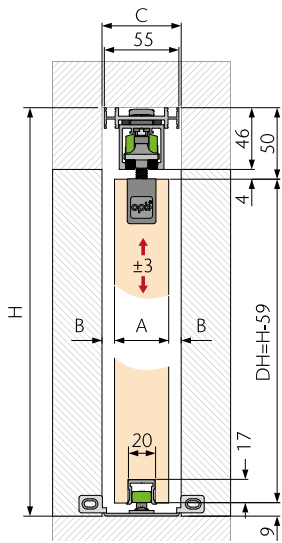
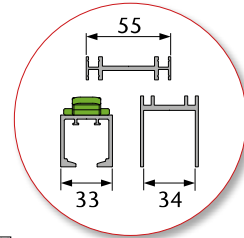

Sonderlösung abgehängte Decke (Seite 94)

Special solution for
suspended ceiling
(Page 94) /
Solution spéciale
de faux-plafond
(Page 94)

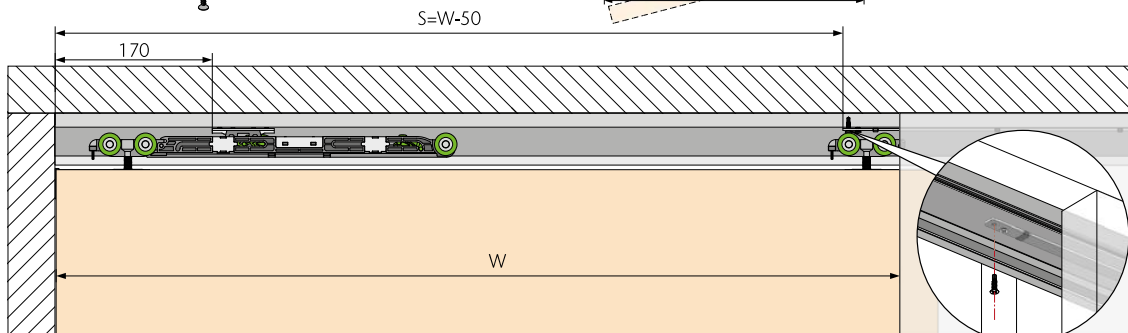
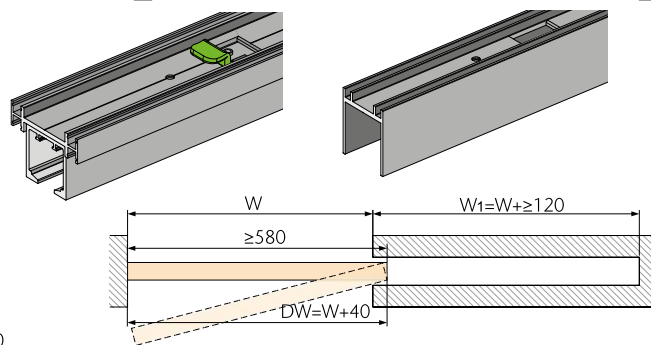
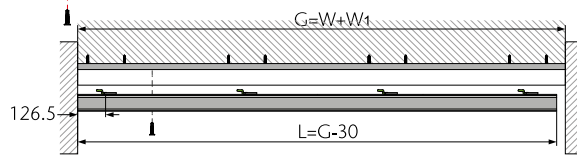
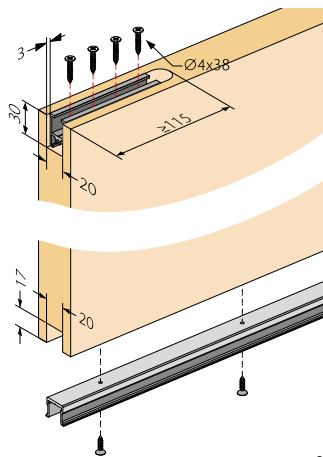

opk Spaceship 80 W Minimal Pocket



Art.-Nr. /
No. / N° d'art.

		≤80	≥580	03-011-703-200
--	--	-----	------	----------------

Konfiguration für 1 Tür

Configuration for 1 door / Configuration pour 1 porte



Laufwerk mit 2-Wege Dämpfer <i>Running part with two-way damper / Train de roulement avec amortisseur 2 voies</i>		1
Laufwerk <i>Running part (roller) / Train de roulement</i>		1
Aktivator lang <i>Activator long / Activeur long</i>		1
Aktivator <i>Activator / Activeur</i>		1
Aufhängung Minimal Holz <i>Minimal bracket wood / Suspension Minimal bois</i>		1
Aufhängung Minimal Pocket Holz <i>Floor guide pocket wood / Suspension Minimal Pocket bois</i>		1
Bodenführung Pocket Holz <i>Floor guide pocket bracket wood / Guide Pocket bois</i>		1
Endstopper <i>End Stopper / Butée d'extrémité</i>		2
Endkappe Führungsschiene <i>Cover cap guiding track / Embout rails de guidage</i>		1
Führungsschwert unten <i>Guiding sword floor bottom / Guide épée en bas</i>		1
Zubehörset Pocket Holz <i>Accessories pocket wood / Set d'accessoires Pocket bois</i>		1

opk Spaceship 80 W Minimal Pocket

Montage Kit (inkl. Lauf- und Führungsschiene)

Kit (incl. running and guiding track) / Kit (rail de roulement et rail de guidage)

Art.-Nr. / No. / N° d'art.	03-011-702-G17 (1700mm)	03-011-702-G20 (2050mm)	03-011-702-G25 (2500mm)	Mg/ Qty/Qté
Lauf- und Montageschiene 33mm vormontierte Haken <i>Run- and Mounting track premounted hooks / Rail de roulement et de montage, crochets prémontés</i>				1
Führungsschiene Holz (1250mm) <i>Guiding track wood (1250mm) / Rail de guidage bois (1250 mm)</i>				1
Konfiguration für 1 Tür <i>Configuration for 1 door (whole set fittings of 03-011-703-200) / Configuration pour 1 porte (ensemble complet de raccords de 03-011-703-200)</i>				1

Alles drin!
All inclusive!
Tout compris!



opk Spaceship 80 G Pocket



Technische Zeichnung

Technical drawing / Plans et schémas

Profilgrößen
Profile dimensions
Tailles des profil

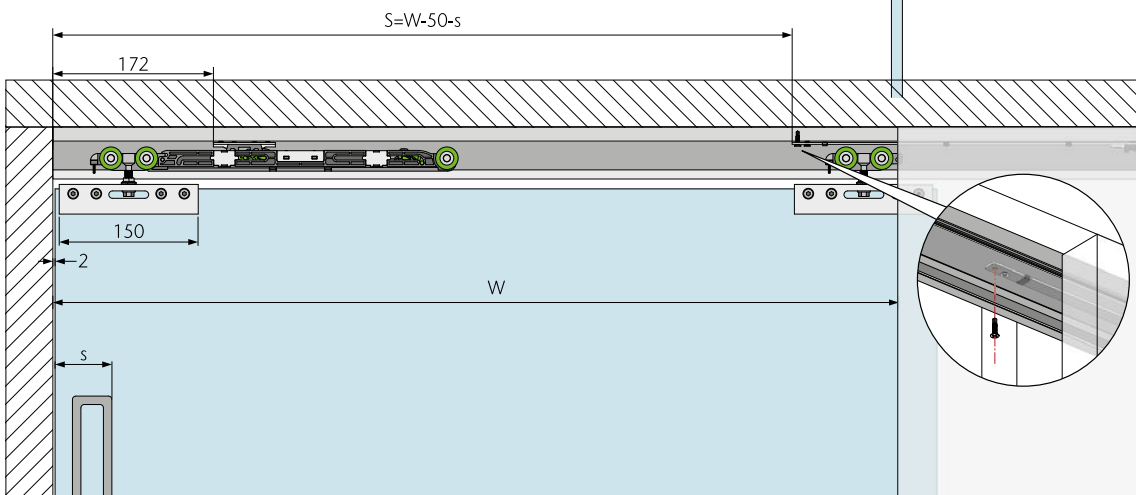
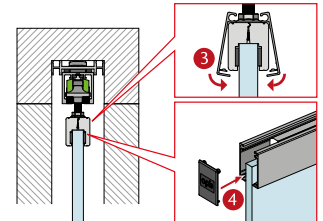
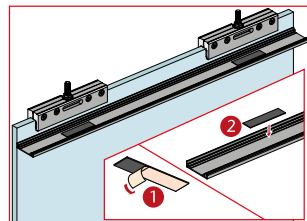
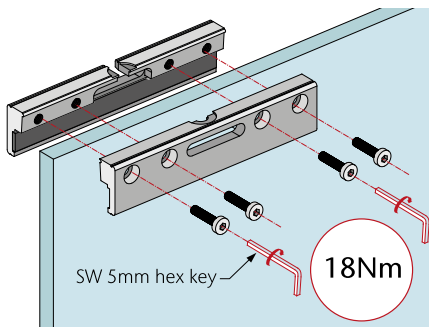
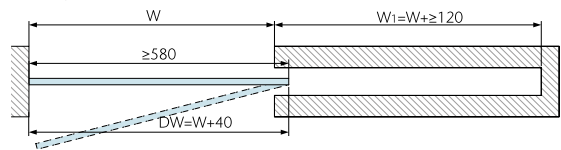
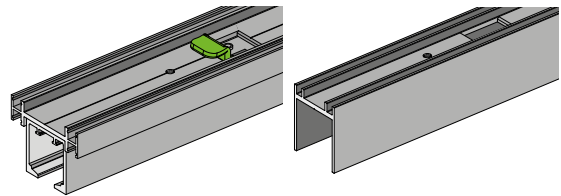
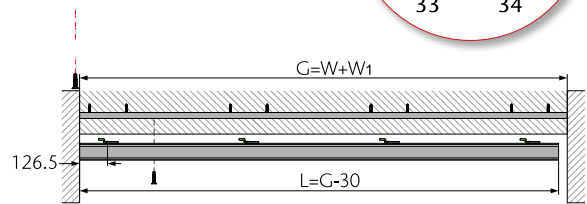
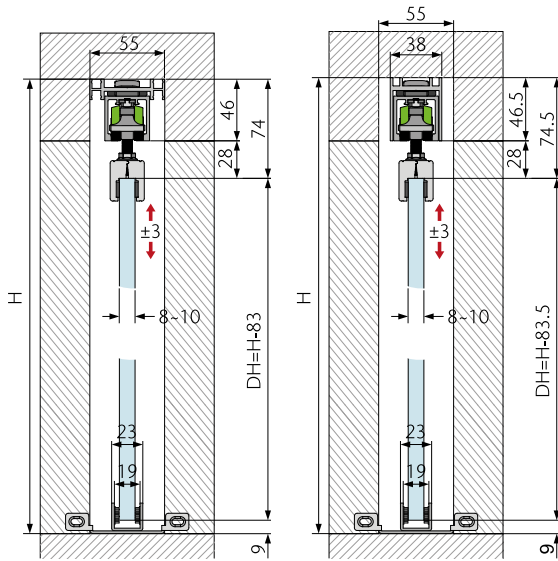
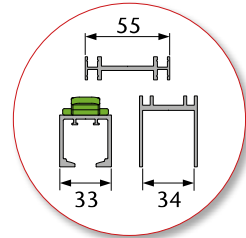

opk Spaceship 80 G Pocket



Art.-Nr. /
No. / N° d'art.

		≤80	≥580	03-011-603-200
--	--	-----	------	----------------

Konfiguration für 1 Tür

Configuration for 1 door / Configuration pour 1 porte



Laufwerk mit 2-Wege Dämpfer <i>Running part with two-way damper / Train de roulement avec amortisseur 2 voies</i>		1
Laufwerk <i>Running part (roller) / Train de roulement</i>		1
Aktivator lang <i>Activator long / Activateur long</i>		1
Aktivator <i>Activator / Activateur</i>		1
Klemmschuh Glas 8/10mm ESG <i>Glass clamp 8/10mm ESG / Casse de serrage verre 8/10mm ESG</i>		2
Bodenführung Pocket Glas inkl. Filz <i>Floor guide pocket glass incl. fleece / Guidage au sol verre, feutre compris</i>		1
Endstopper <i>End Stopper / Butée d'extrémité</i>		2
Zubehörset Pocket Glas <i>Accessories pocket glass / Set d'accessoires Pocket verre</i>		1

opk Spaceship 80 Push To Open



Technische Zeichnung Technical drawing / Plans et schémas

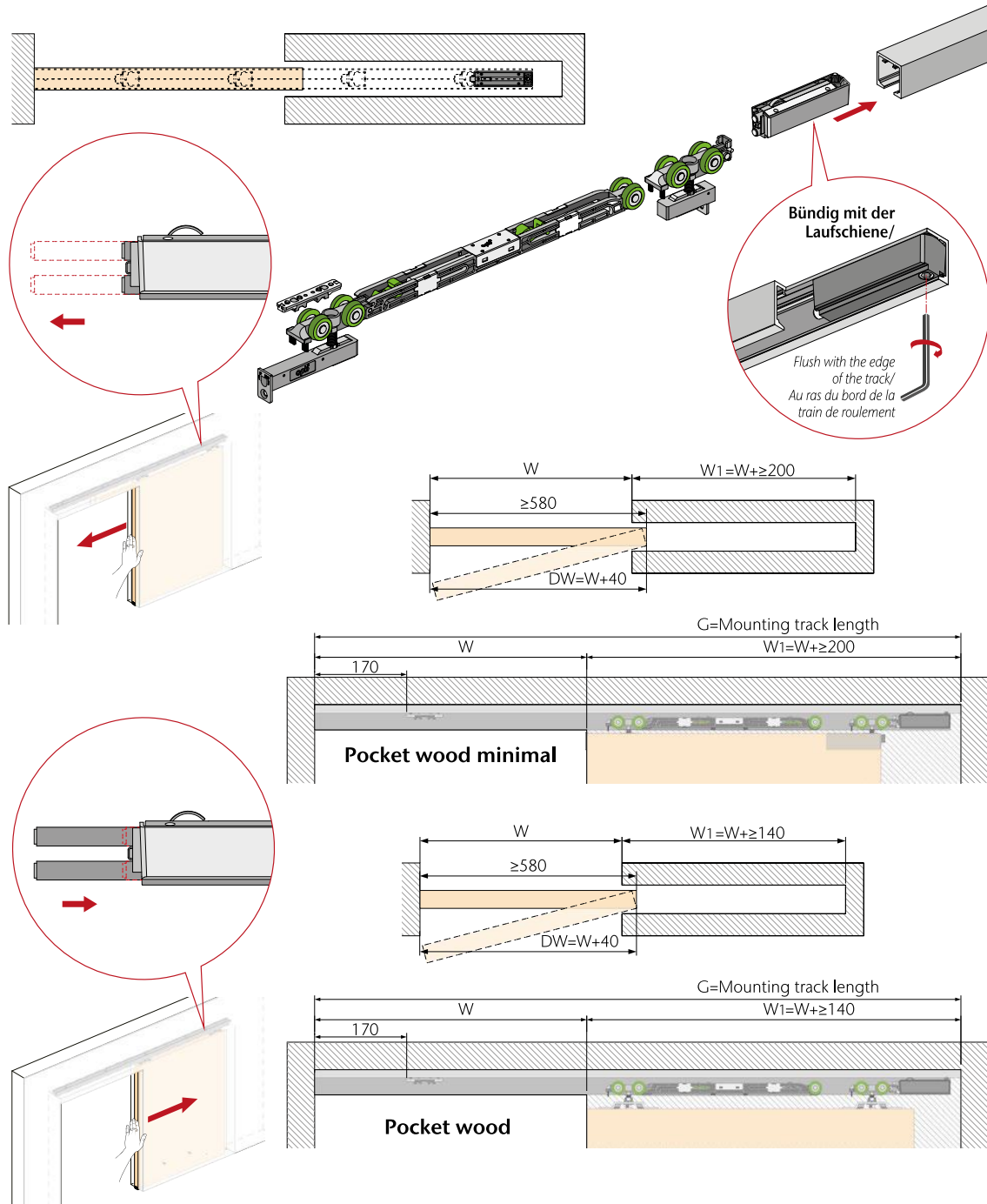

opk Spaceship 80 Push To Open



Art.-Nr. /
No. / N° d'art.

		≤80	≥580	03-015-003-003

Konfiguration für 1 Tür

Configuration for 1 door / Configuration pour 1 porte



Laufwagen mit Kontaktplatte <i>Single roller with contact plate / Train de roulement avec plaque de contact</i>		1 Satz/ 1 set/ 1 set
Pocket Push to Open <i>Pocket Push to Open / Pocket Push to Open</i>		

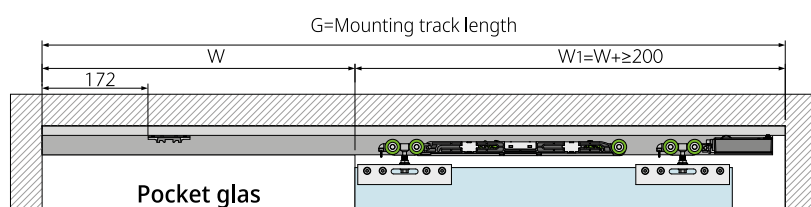
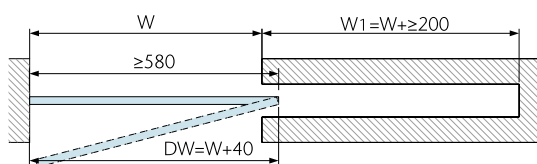









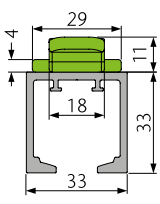

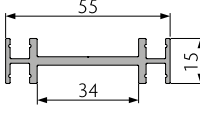
opk Spaceship 80 W/G Pocket

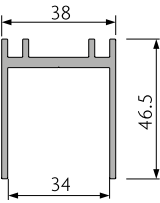

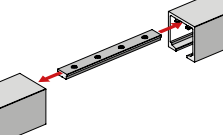
Schienen, Zubehör

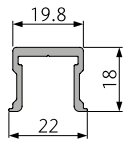
Tracks, accessories / Rails, accessoires

Produktbeschreibung Product description / Description du produit		Material Matériel	Farbe Finish / Couleur	Länge (mm) Length / Longueur	Art.-Nr. No./ N° d'art.
Laufschiene 33mm vormontierte Haken Running track premounted hooks/ Rail de roulement crochets pré- montés 		Aluminium eloxiert Anodized aluminium Aluminium anodisé	Silber Silver Argent	1700	03-016-252-G17
				2050	03-016-252-G20
				2500	03-016-252-G25
				3000	03-016-252-G30
Montageschiene 55x15mm Pocket Mounting track 55x15mm Rail de montage 55x15mm 		Aluminium Aluminium Aluminium	Roh Raw Brut	1700	03-016-252-F17
				2050	03-016-252-F20
				2500	03-016-252-F25
				3000	03-016-252-F30
Montageschiene - U-Profil für deckenbündige Montage Mounting track - U-profile for installation flush / Rail de montage - profilé en U pour un montage affleuré au plafond 		Aluminium Aluminium Aluminium	Silber Silver Argent	2050	03-018-100-020
				3000	03-018-100-030
Verbinder Laufschiene Connecting bracket / Connecteur de rails 		Aluminium Aluminium Aluminium	Roh Raw Brut	100	03-015-000-400
Führungsschiene Holz Guiding track wood / Rail de guidage bois 		Aluminium Aluminium Aluminium	Roh Raw Brut	1250	03-017-100-012
				2500	03-017-100-025
Abdeckkappe für Führungsschiene Cover cap guiding track / Embout rail de guidage 		Kunststoff Plastic Plastique	Schwarz Black Noir	1 Stück 1 pcs 1 pcs	03-017-170-000

opk Spaceship 80 W/G Pocket



Schienen, Zubehör

Tracks, accessories / Rails, accessoires

Produktbeschreibung <i>Product description / Description du produit</i>		Material <i>Material / Matériel</i>	Farbe <i>Finish / Couleur</i>	Länge (mm) <i>Length / Longueur</i>	Art.-Nr. <i>No./ N° d'art.</i>
Blende Glasklemmschuh <i>cover glass clamp / Cache cosse de serrage verre</i> 		Aluminium eloxiert <i>Anodized aluminium Aluminium anodisé</i>	Silber <i>Silver Argent</i>	2500	03-016-25D-025
			Schwarz <i>Black Noir</i>	2500	70-016-25D-025
Endkappe Glasklemmschuh <i>coverup glass clamp / Embout cosse de serrage verre</i> 		Kunststoff <i>Plastic Plastique</i>	Silber <i>Silver Argent</i>	2 Stück 2 piece 2 pièce	03-016-34D-003
			Schwarz <i>Black Noir</i>	2 Stück 2 piece 2 pièce	70-016-34D-003

Sonderlösung abgehängte Decke

Special solution for suspended ceiling / Solution spéciale de faux-plafond

Produktbeschreibung <i>Product description / Description du produit</i>		Material <i>Material / Matériel</i>	Farbe <i>Finish / Couleur</i>	Länge (mm) <i>Length / Longueur</i>	Art.-Nr. <i>No./ N° d'art.</i>
Aufhängung Minimal Holz incl. Abdeckkappe mit M8x40 längerer Schraube <i>Minimal bracket wood incl. cover cap with M8x40 screw longer version / Suspension Minimal bois inclus Capuchon avec M8x40 vis version longue</i>		Aluminium eloxiert <i>Anodized aluminium Aluminium anodisé</i>	Silber <i>Silver Argent</i>	M8 x 40 mm	03-012-205-001
Aufhängung Minimal Pocket Holz incl. Abdeckkappe mit M8x40 längerer Schraube <i>Floor guide pocket wood incl. cover cap with M8x40 screw longer version / Suspension Minimal Pocket bois inclus Capuchon avec M8x40 vis version longue</i>		Aluminium eloxiert <i>Anodized aluminium Aluminium anodisé</i>	Silber <i>Silver Argent</i>	M8 x 40 mm	03-012-706-001

Bau Systeme
Building systems / Systèmes de bâtiment