

opk SPACESHIP 80

EIN SYSTEM. FAST UNENDLICHE EINSATZMÖGLICHKEITEN.
ONE SYSTEM. ALMOST INFINITE POSSIBILITIES OF USE.
UN SYSTÈME. DES POSSIBILITÉS D'UTILISATION QUASI INFINIES.

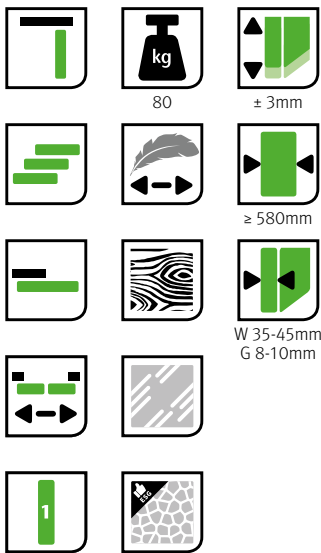

W 35-45mm
G 8-10mm

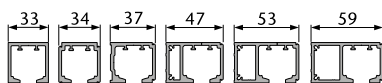

Für jede Anwendung das passende Laufprofil
*The right running profile for every application /
Le bon profil de course pour chaque application*



opk Spaceship 80 W

Deckenmontage

Ceiling Mounting /
Montage au plafond



Technische Zeichnung

Technical drawing / Plans et schémas

Profilgrößen
Profile dimensions
Tailles des profil

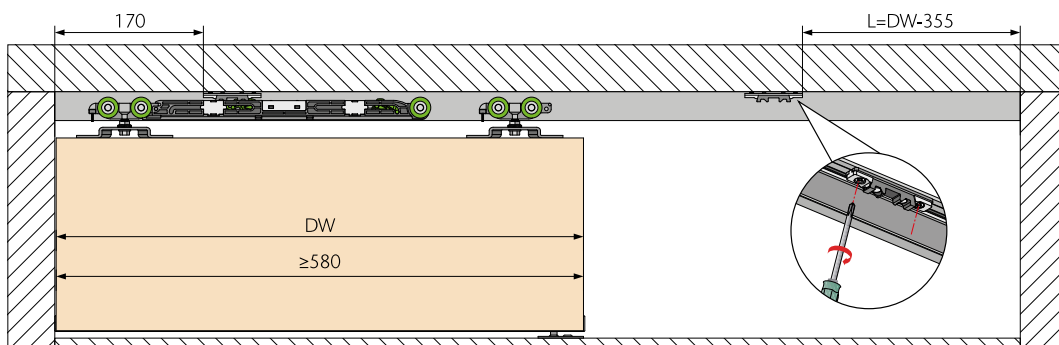
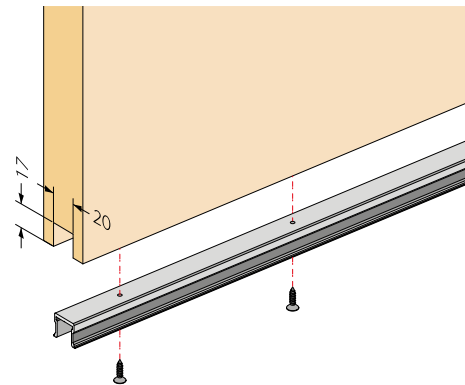
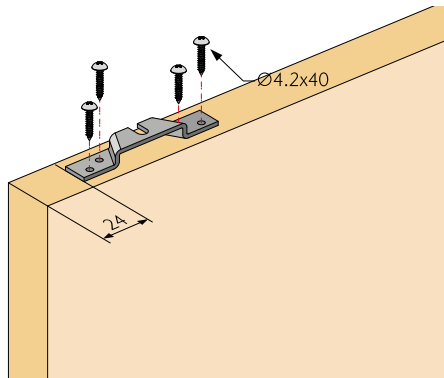
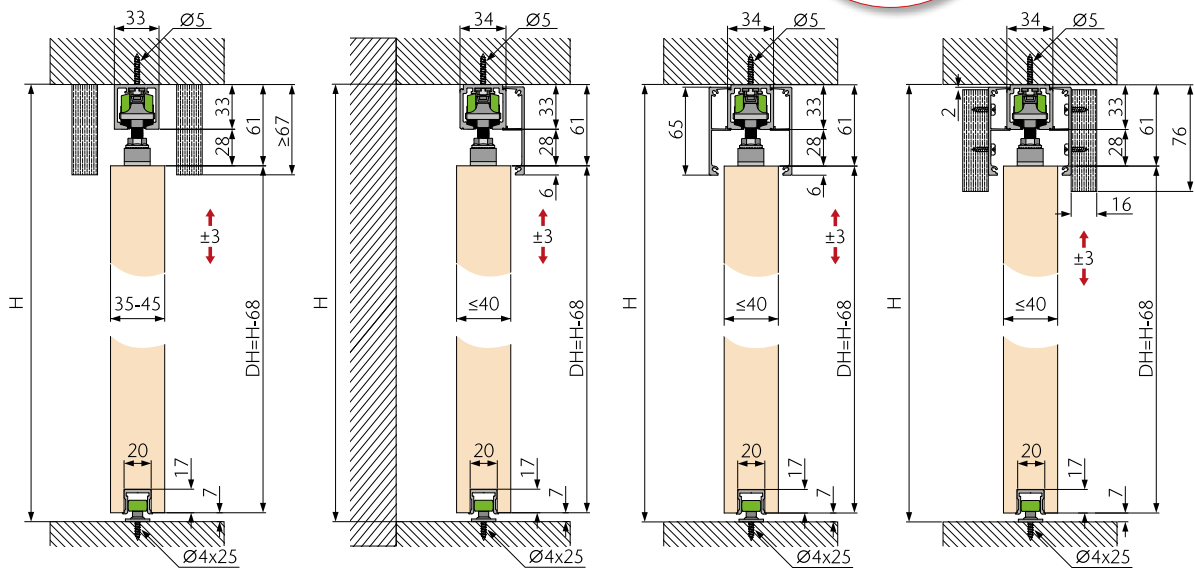
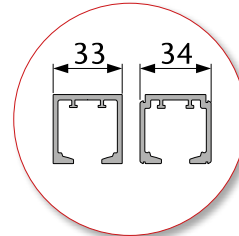

opk Spaceship 80 W



Deckenmontage

Ceiling Mounting /
Montage au plafond



Art.-Nr. /
No. / N° d'art.

		≤80	≥580	03-011-103-200
--	--	-----	------	----------------

Konfiguration für 1 Tür

Configuration for 1 door / Configuration pour 1 porte



Laufwerk mit 2-Wege Dämpfer <i>Running part with two-way damper / Train de roulement avec amortisseur 2 voies</i>		1
Laufwerk <i>Running part (roller) / Train de roulement</i>		1
Aktivator <i>Activator / Activeur</i>		2
Aufhängung Holz <i>Suspension bracket wood / Suspension bois</i>		2
Bodenführung 1 Rolle Holz <i>Floor guide 1 roller wood / Guidage au sol 1 rouleau bois</i>		1
Endstopper <i>End Stopper / Butée d'extrémité</i>		2
Endkappe Führungsschiene <i>Cover cap guiding track / Embout rails de guidage</i>		2
Führungsschwert unten <i>Guiding sword floor bottom / Guide épée en bas</i>		1
Zubehörset Holz <i>Accessories wood / Set d'accessoires bois</i>		1

opk Spaceship 80 W

Deckenmontage Kit (inkl. Lauf- und Führungsschiene)

Ceiling Mounting kit (incl. running and guiding track) /
Montage au plafond kit (incl. rail de roulement et rail de guidage)

Art.-Nr. / No. / N° d'art.	03-011-102-E20 (2050mm)	Mg/ Qty/Qté
Laufschiene 33mm <i>Running track 33mm / Rail de roulement 33mm</i>		1
Führungsschiene Holz (1250mm) <i>Guiding track wood (1250mm) / Rail de guidage bois (1250 mm)</i>		1
Konfiguration für 1 Tür <i>Configuration for 1 door (whole set fittings of 03-011-103-200) / Configuration pour 1 porte (ensemble complet de raccords de 03-011-103-200)</i>		1



Alles drin!
All inclusive!
Tout compris!

opk Spaceship 80 W Minimal

Deckenmontage

Ceiling Mounting /
Montage au plafond



Technische Zeichnung

Technical drawing / Plans et schémas

Profilgrößen
Profile dimensions
Tailles des profil

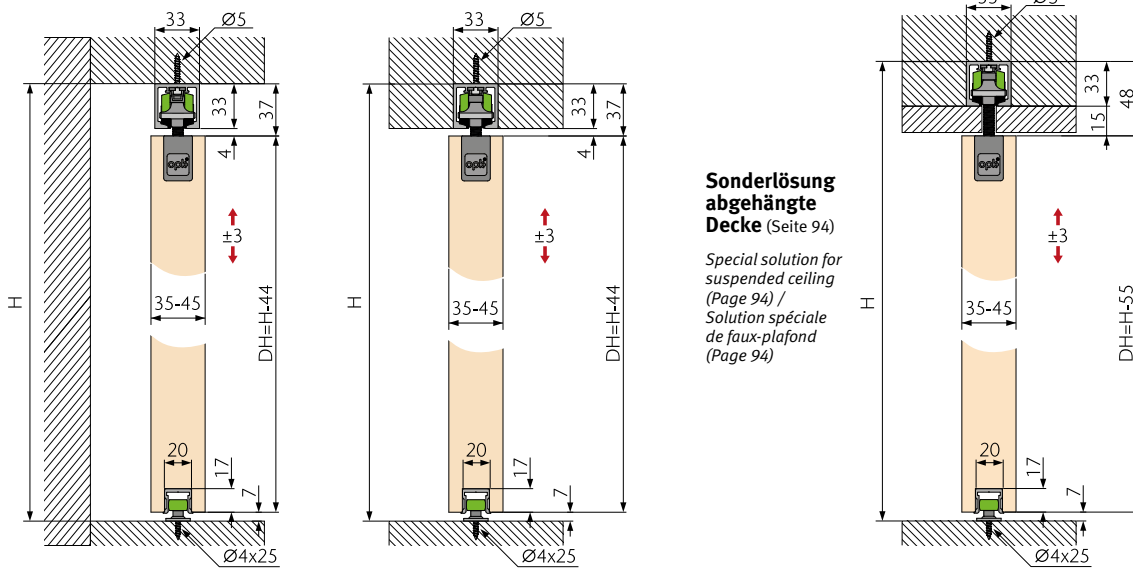
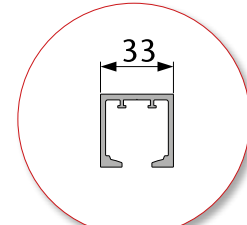

Sonderlösung abgehängte Decke (Seite 94)

Special solution for
suspended ceiling
(Page 94) /
Solution spéciale
de faux-plafond
(Page 94)

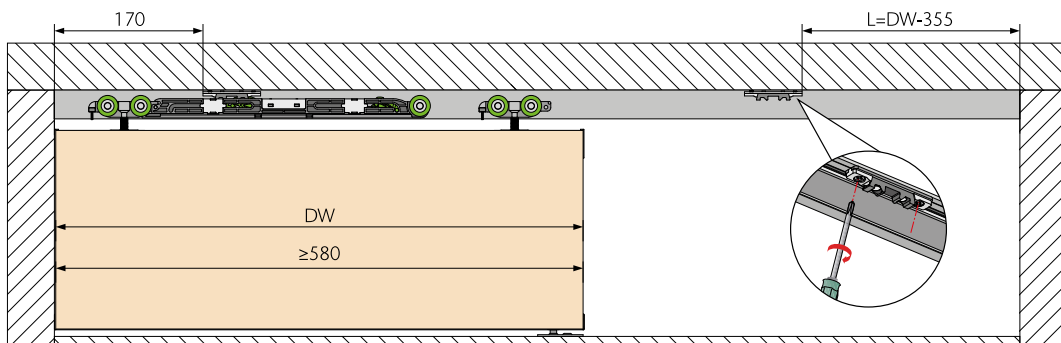
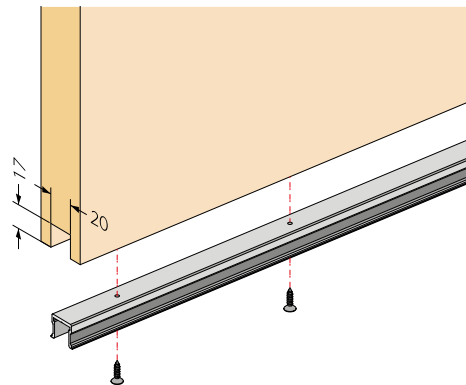
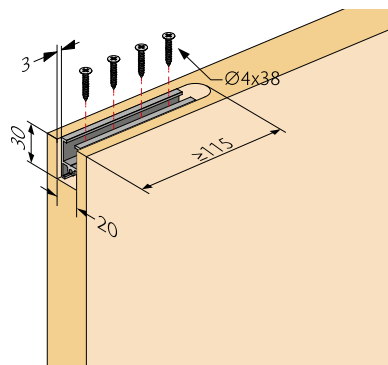

opk Spaceship 80 W Minimal



Deckenmontage

Ceiling Mounting /
Montage au plafond



Art.-Nr. /
No. / N° d'art.

		≤80	≥580	03-011-203-200
--	--	-----	------	----------------

Konfiguration für 1 Tür

Configuration for 1 door / Configuration pour 1 porte



Laufwerk mit 2-Wege Dämpfer <i>Running part with two-way damper / Train de roulement avec amortisseur 2 voies</i>		1
Laufwerk <i>Running part (roller) / Train de roulement</i>		1
Aktivator <i>Activator / Activeur</i>		2
Aufhängung Minimal Holz <i>Minimal bracket wood / Suspension Minimal bois</i>		2
Bodenführung 1 Rolle Holz <i>Floor guide 1 roller wood / Guidage au sol 1 rouleau bois</i>		1
Endstopper <i>End Stopper / Butée d'extrémité</i>		2
Endkappe Führungsschiene <i>Cover cap guiding track / Embout rails de guidage</i>		2
Führungsschwert unten <i>Guiding sword floor bottom / Guide épée en bas</i>		1
Zubehörset Holz Minimal <i>Accessories wood minimal / Set d'accessoires Minimal bois</i>	x1 x2 x2 x8	1

opk Spaceship 80 W Minimal

Deckenmontage Kit (inkl. Lauf- und Führungsschiene)

Ceiling Mounting kit (incl. running and guiding track) /
Montage au plafond kit (incl. rail de roulement et rail de guidage)

Art.-Nr. / No. / N° d'art.	03-011-202-E20 (2050mm)	Mg/ Qty/Qté
Laufschiene 33mm <i>Running track 33mm / Rail de roulement 33mm</i>		1
Führungsschiene Holz (1250mm) <i>Guiding track wood (1250mm) / Rail de guidage bois (1250 mm)</i>		1
Konfiguration für 1 Tür <i>Configuration for 1 door (whole set fittings of 03-011-203-200) / Configuration pour 1 porte (ensemble complet de raccords de 03-011-203-200)</i>		1



Alles drin!
All inclusive!
Tout compris!

opk Spaceship 80 G

Deckenmontage

Ceiling Mounting /
Montage au plafond



Technische Zeichnung

Technical drawing / Plans et schémas

Profilgrößen
Profile dimensions
Tailles des profil

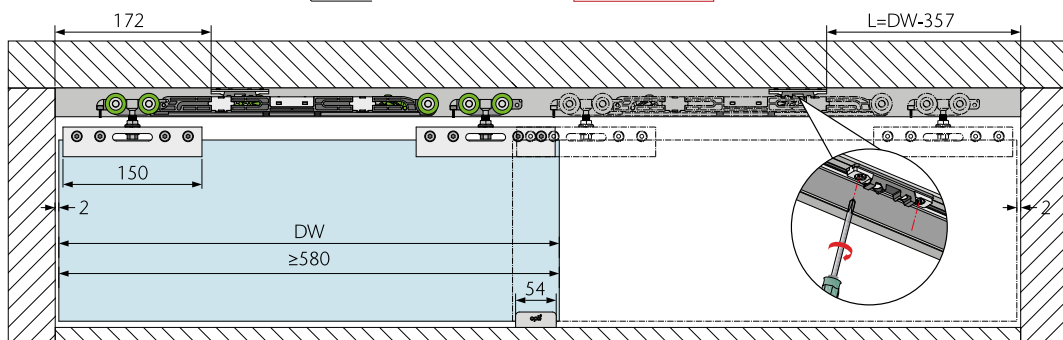
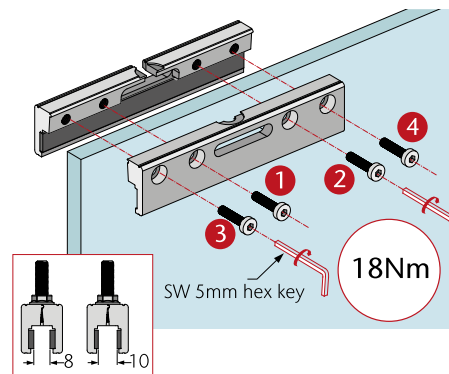
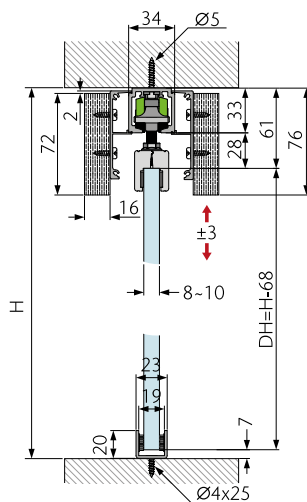
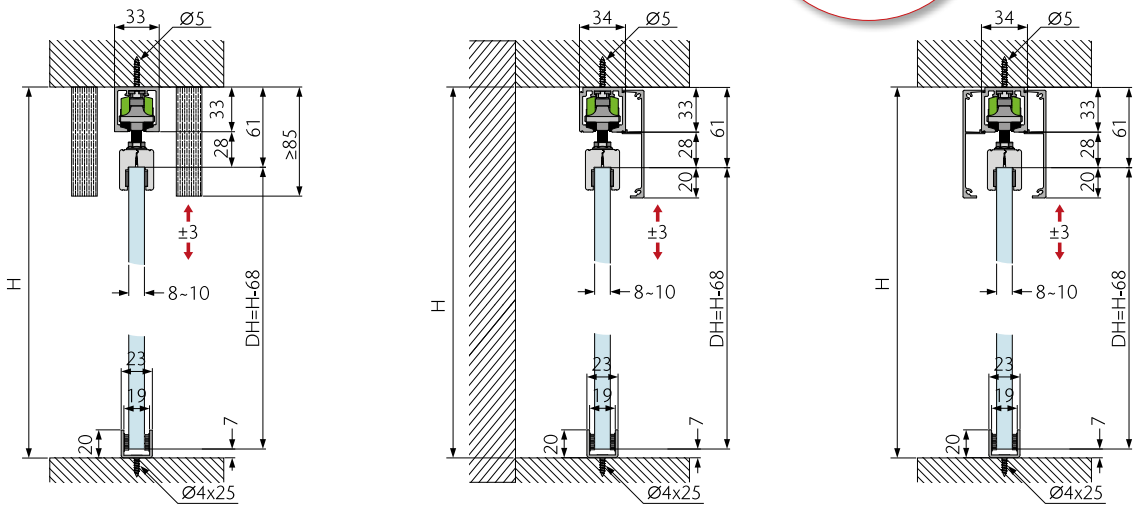
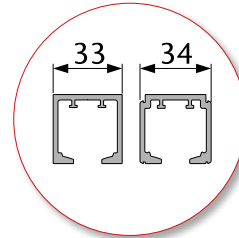

opk Spaceship 80 G

Deckenmontage

Ceiling Mounting /

Montage au plafond



Art.-Nr. /
No. / N° d'art.

		≤80	≥580	03-011-303-200
--	--	-----	------	----------------

Konfiguration für 1 Tür

Configuration for 1 door / Configuration pour 1 porte



Laufwerk mit 2-Wege Dämpfer <i>Running part with two-way damper / Train de roulement avec amortisseur</i>		1
Laufwerk <i>Running part (roller) / Train de roulement</i>		1
Aktivator <i>Activator / Activeur</i>		2
Klemmschuh Glas 8/10mm ESG <i>Glass clamp 8/10mm ESG / Casse de serrage verre 8/10mm ESG</i>		2
Bodenführung Glas inkl. Filz <i>Floor guide glass incl. fleece / Guidage au sol verre, feutre compris</i>		1
Endstopper <i>End Stopper / Butée d'extrémité</i>		2
Zubehörset Glas <i>Accessories glass / Set d'accessoires verre</i>	x1 x1 x2	1

opk Spaceship 80 G

Deckenmontage und Festglas

Ceiling Mounting and fixed glass /
Montage au plafond et verre fixe



Technische Zeichnung

Technical drawing / Plans et schémas

Profilgrößen
Profile dimensions
Tailles des profil

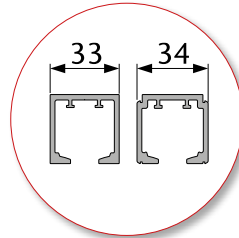

A	B	C	D
23mm	20mm	8mm	5mm
25mm	19mm	10mm	4mm

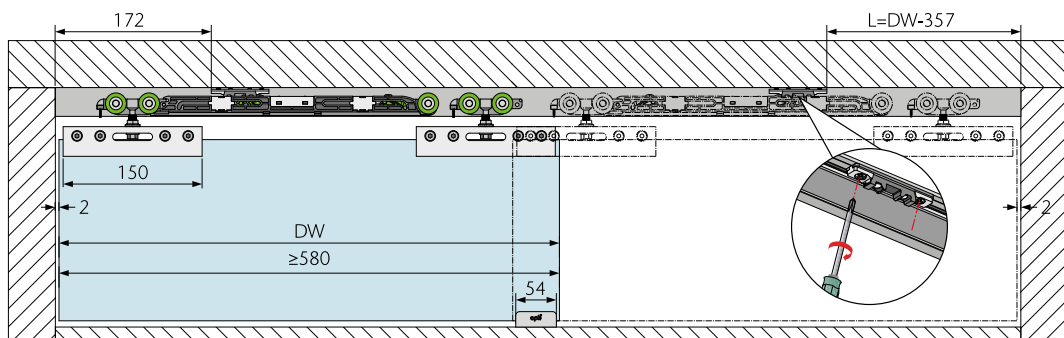
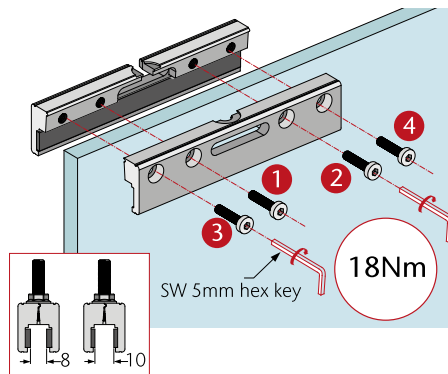
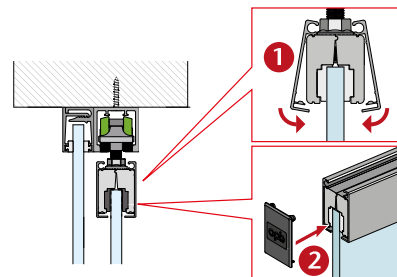
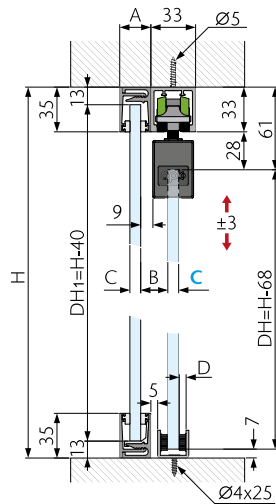

opk Spaceship 80 G

Deckenmontage und Festglas

Ceiling Mounting and fixed glass /

Montage au plafond et verre fixe



Art.-Nr. /
No. / N° d'art.

		≤80	≥580	03-011-303-200
--	--	-----	------	----------------

Konfiguration für 1 Tür

Configuration for 1 door / Configuration pour 1 porte



Laufwerk mit 2-Wege Dämpfer Running part with two-way damper / Train de roulement avec amortisseur		1
Laufwerk Running part (roller) / Train de roulement		1
Aktivator Activator / Activeur		2
Klemmschuh Glas 8/10mm ESG Glass clamp 8/10mm ESG / Cosse de serrage verre 8/10mm ESG		2
Bodenführung Glas inkl. Filz Floor guide glass incl. fleece / Guidage au sol verre, feutre compris		1
Endstopper End Stopper / Butée d'extrémité		2
Zubehörset Glas Accessories glass / Set d'accessoires verre	x1 x1 x2	1

Schienen, Zubehör

Tracks, accessories / Rails, accessoires











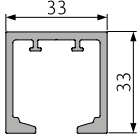

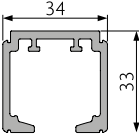
Produktbeschreibung Product description/Description du produit	Material Material/Matériau	Farbe Finish/Couleur	Länge (mm) Length/Longueur	Art.-Nr. No./ N° d'art.
opk Startrack Festglas-Profil Startrack fixed glass profile / Startrack profil de verre fixe		Silber Silver Argent	2500	20-0100-002-11
		Schwarz Black Noir	2500	20-0100-002-13
opk Startrack Festglas-Endkappe Startrack fixed glass End cap / Startrack Embout de verre fixe		Silber Silver Argent	8/8,76mm	20-9001-008-41
			10/10,76mm	20-9001-010-41
			12/12,76mm	20-9001-012-41
		Schwarz Black Noir	8/8,76mm	20-9001-008-47
			10/10,76mm	20-9001-010-47
			12/12,76mm	20-9001-012-47
opk Startrack Festglas-Fixierung Startrack fixed glass fixation / Startrack fixation de verre fixe		Schwarz Black Noir	8/8,76mm	20-9004-008-41
			10/10,76mm	20-9004-010-41
			12/12,76mm	20-9004-012-41

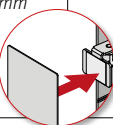
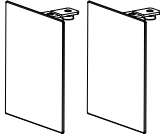
opk Spaceship 80 W/G

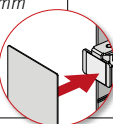
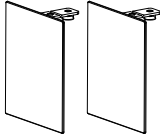

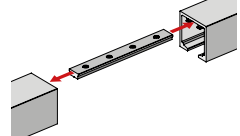
Schienen, Zubehör

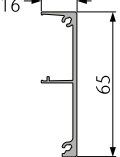
Tracks, accessories / Rails, accessoires

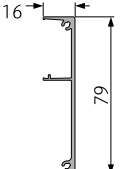





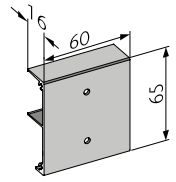

Produktbeschreibung Product description / Description du produit		Material Material / Matériel	Farbe Finish / Couleur	Länge (mm) Length / Longueur	Art.-Nr. No./ N° d'art.
Laufschiene 33mm Running track / Rail de roulement  	Aluminium eloxiert Anodized aluminium Aluminium anodisé	Silber Silver Argent	2050	03-016-252-E20	
			2500	03-016-252-E25	
			3500	03-016-252-E35	
			5800	03-016-252-E58	
Laufschiene clip-in Blende Running track click in cover / Cache rail de roulement à clipser  	Aluminium eloxiert Anodized aluminium Aluminium anodisé	Silber Silver Argent	2050	03-016-252-H20	
			2500	03-016-252-H25	
			3500	03-016-252-H35	
			5800	03-016-252-H58	
Endkappe W 67x61 mm Endcap W 67x61 mm / Embout W 67x61mm   	Aluminium Aluminium Aluminium	Silber Silver Argent	1 Paar/2 Stück 1 set/2 pcs 1 set/2 pcs	03-016-34C-F00	
Endkappe G 81x61 mm Endcap G 81x61 mm / Embout G 81x61mm   	Aluminium Aluminium Aluminium	Silber Silver Argent	1 Paar/2 Stück 1 set/2 pcs 1 set/2 pcs	03-016-34C-F01	
Verbinder Laufschiene Connecting bracket / Connecteur de rails  	Aluminium Aluminium Aluminium	Roh Raw Brut	100	03-015-000-400	
Blende 65mm Decorative cover / Cache  	Aluminium eloxiert Anodized aluminium Aluminium anodisé	Silber Silver Argent	2050	03-016-25A-020	
			2500	03-016-25A-025	
			3500	03-016-25A-035	
			5800	03-016-25A-058	
Blende 79mm Decorative cover / Cache  	Aluminium eloxiert Anodized aluminium Aluminium anodisé	Silber Silver Argent	2050	03-016-25B-020	
			2500	03-016-25B-025	
			3500	03-016-25B-035	
			5800	03-016-25B-058	

opk Spaceship 80 W/G

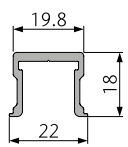

Schienen, Zubehör

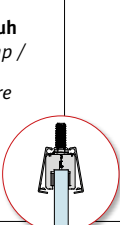
Tracks, accessories / Rails, accessoires

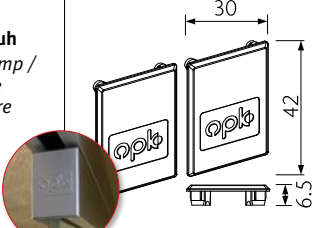
Produktbeschreibung <i>Product description / Description du produit</i>	Material <i>Material / Matériel</i>	Farbe <i>Finish / Couleur</i>	Länge (mm) <i>Length / Longueur</i>	Art.-Nr. <i>No./ N° d'art.</i>
Halterung Holzblende <i>Bracket wood cover / Support pour cache bois</i>  	Aluminium eloxiert <i>Anodized aluminium / Aluminium anodisé</i>	Silber <i>Silver / Argent</i>	60	03-016-25D-000
Führungsschiene Holz <i>Guiding track wood / Rail de guidage bois</i>  	Aluminium <i>Aluminium / Aluminium</i>	Roh <i>Raw / Brut</i>	1250	03-017-100-012
			2500	03-017-100-025
Abdeckkappe für Führungsschiene <i>Cover cap guiding track / Embout rail de guidage</i>  	Kunststoff <i>Plastic / Plastique</i>	Schwarz <i>Black / Noir</i>	1 Stück 1 pcs 1 pcs	03-017-170-000
Blende Glasklemmschuh <i>cover glass clamp / Cache cosse de serrage verre</i>  	Aluminium eloxiert <i>Anodized aluminium / Aluminium anodisé</i>	Silber <i>Silver / Argent</i>	2500	03-016-25D-025
Endkappe Glasklemmschuh <i>coverup glass clamp / Embout cosse de serrage verre</i>  	Kunststoff <i>Plastic / Plastique</i>	Silber <i>Silver / Argent</i>	2 Stück 2 piece 2 pièce	03-016-34D-003

Bausysteme
Building systems /
Systèmes de construction

opk Spaceship 80

**INNOVATIVE
ZWEIWEGEDÄMPFUNG
AB 580 MM TÜRBREITE**
*INNOVATIVE TWO-WAY DAMPING
FROM 580 MM DOOR WIDTH
AMORTISSEUR DEUX VOIES INNOVANT A
PARTIR DE 580 MM DE LARGEUR DE PORTE*

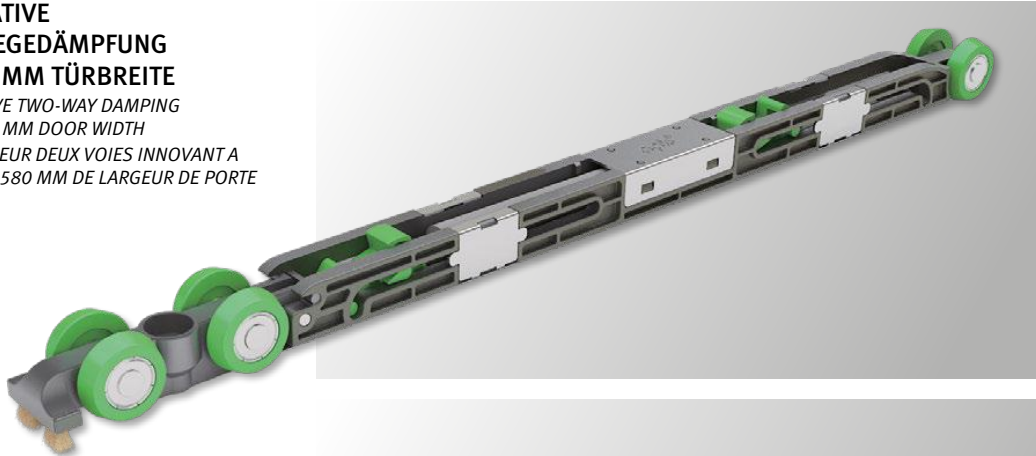

**KUGELGELAGERTE LAUFROLLE FÜR
EINEN OPTIMALEN, LEISEN LAUF
MIT INTEGRIERTER
REINIGUNGSBÜRSTE**

*BALL BEARING MOUNTED ROLLER
WITH INTEGRATED CLEANING BRUSH
ROULETTE À ROULEMENT À BILLES POUR UN
ROULEMENT SILENCIEUX, OPTIMAL AVEC BROS-
SE DE NETTOYAGE INTÉGRÉE*

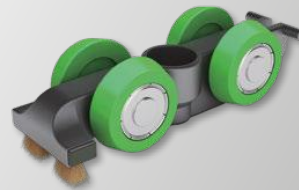

**KUGELGELAGERTE
BODENFÜHRUNG FÜR
KOMFORTABLE BEDienung OHNE
VIBRATIONEN**

*BALL BEARING FLOOR GUIDE FOR COMFORT-
ABLE OPERATION WITHOUT VIBRATIONS
GUIDAGE AU SOL À ROULEMENT À BILLES
POUR UNE UTILISATION CONFORTABLE SANS
VIBRATIONS*

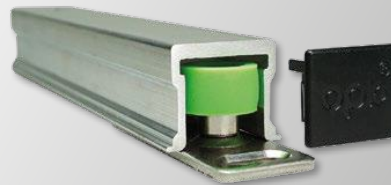

**PASST IMMER –
ZARGE ODER SOCKELLEISTE, FÜR
JEDE ANWENDUNG
DAS RICHTIGE PROFIL**

*ALWAYS FITS – FRAME OR SKIRTING BOARD,
FOR EVERY APPLICATION THE RIGHT PROFILE
CONVIENT TOUJOURS – CHAMBRANLE OU
PLINTHE, LE BON PROFIL DE COURSE
POUR CHAQUE APPLICATION*

